

SPICE thermal model

BUK7M45-40E

Symbol	Parameter	Conditions	Min	Typ	Max	Unit
$R_{th(j-mb)}$	thermal resistance from junction to mounting base		-	-	4.80	K/W

C_{th1}	6.427E-06 F
C_{th2}	7.431E-05 F
C_{th3}	4.432E-05 F
C_{th4}	1.193E-03 F
C_{th5}	3.891E-04 F
C_{th6}	4.302E-03 F
C_{th7}	2.916E-03 F
C_{th8}	1.758E+01 F
R_{th1}	6.908E-03 Ω
R_{th2}	1.926E-02 Ω
R_{th3}	1.262E-01 Ω
R_{th4}	9.094E-02 Ω
R_{th5}	1.997E+00 Ω
R_{th6}	2.197E+00 Ω
R_{th7}	3.449E-01 Ω
R_{th8}	1.685E-02 Ω

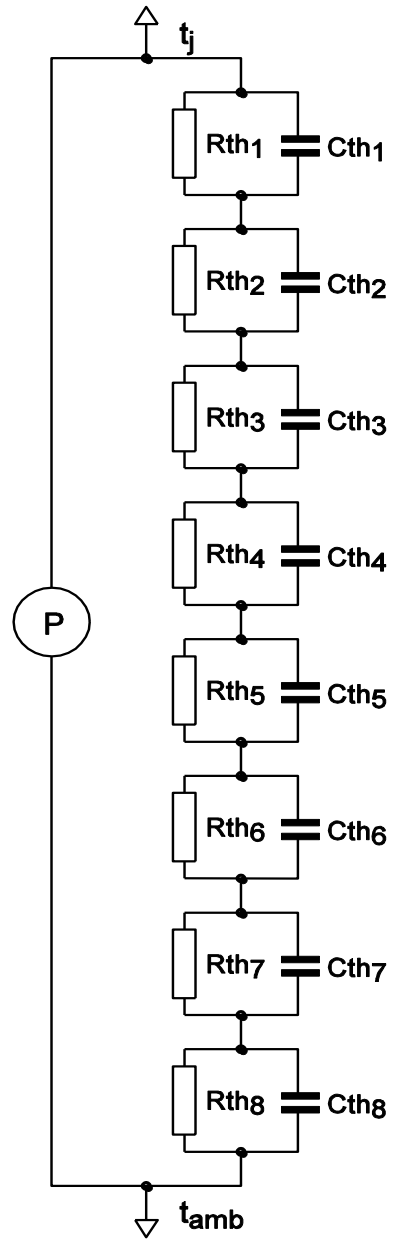

Part: BUK7M45-40E
 Date: 3/3/2016
 Model Rth 4.80 K/W